

HRT 46B Ex n

Diffuse reflection light scanner with background suppression

Dimensioned drawing

en 07-2017/02 50109199-04

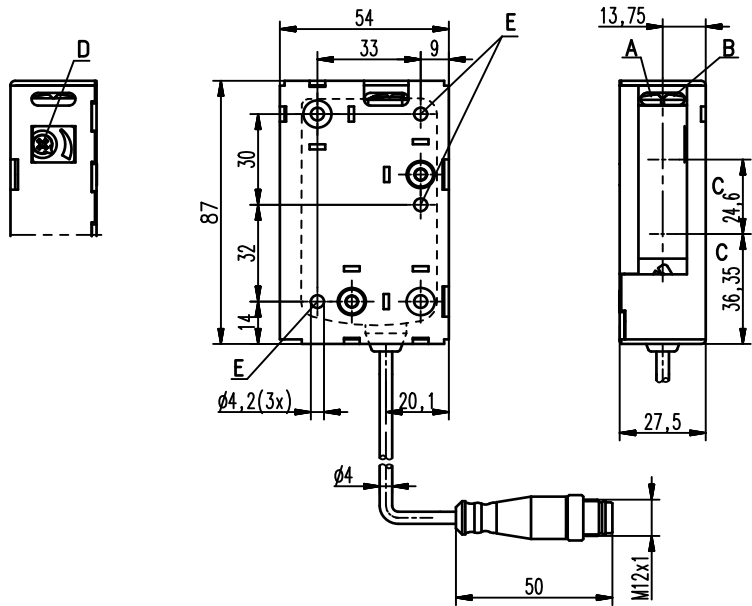

- A** Green indicator diode
- B** Yellow indicator diode
- C** Optical axis
- D** Scanning range adjustment
- E** Fastening hole

Electrical connection

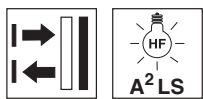
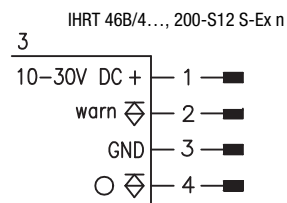
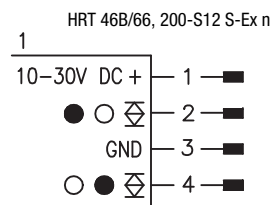

0 ... 2,500mm
1,200mm with
black-white error < 10%



- Adjustable scanner with background suppression
- Reliable detection of light and dark, as well as inclined or sloped surfaces
- Exact scanning range adjustment through multiturn potentiometer
- Complementary switching outputs for optimal adaptation to the application
- Warning output - for increased availability
- A²LS - Active Ambient Light Suppression
- Ex II 3G Ex nA op is IIB T4 Gc X
- Ex II 3D Ex tc IIIC T90°C Dc IP67 X



Accessories:

(available separately)

- Mounting systems (BT 46, BT 46.1, BT 46.1.5, BT 46.2)
- M12 connectors (KD ...)
- Ready-made cables (KD ...)
- Interlocking guard K-VM12-Ex (Part No. 501 09217)

We reserve the right to make changes • PAL_HRT46BEX_en_50109199_04.fm

Specifications

Optical data

Typ. scanning range limit (white 90%) ¹⁾	0 ... 2,500mm
Scanning range ²⁾	see tables
Adjustment range	120 ... 2,500mm
Light source ³⁾	LED (modulated light)
Wavelength	850nm

Infrared light

Timing

Switching frequency	200Hz
Response time	2,5ms
Delay before start-up	≤ 100ms

Electrical data

With transistor switching outputs

Operating voltage U_B	10 ... 30VDC (incl. residual ripple)
Residual ripple	≤ 15% of U_B
Open-circuit current	≤ 30mA
Switching output	2 push-pull switching outputs ⁴⁾
	pin 2: PNP dark switching, NPN light switching
	pin 4: PNP light switching, NPN dark switching
	2 PNP switching outputs
	pin 2: PNP dark switching, pin 4: PNP light switching
	pin 2: PNP dark switching, pin 4: PNP light switching
	PNP switching output, pin 4: PNP light switching
	PNP switching output, pin 4: PNP dark switching
	$\geq (U_B - 2V) \leq 2V$
	max. 100mA

Signal voltage high/low
Output current

With relay switching output

Operating voltage U_B ⁴⁾	24VDC ± 10%
Open-circuit current	≤ 40mA
Switching output	relay, make-contact between pin 2 and pin 4, light switching ⁵⁾
Switching voltage	30VAC/DC, max. 200mA
Switching power	max. 6VA, cos φ = 1

Indicators

Green LED	ready
Yellow LED	reflection
Yellow LED, flashing	reflection, no performance reserve

Mechanical data

Housing ⁶⁾ / optics cover	plastic / plastic
Weight	50g (with connector) / 65g (with cable and conn.)
Connection type	cable with M12 connector, cable length: 200mm

Environmental data

Ambient temp. (operation/storage)	-30°C ... +60°C / -30°C ... +70°C
Protective circuit ⁷⁾	2, 3
VDE safety class ⁸⁾	II, all-insulated
Protection class	IP 67, IP 69K
Light source	exempt group (in acc. with EN 62471)
Standards applied	IEC 60947-5-2

Explosion protection

Certification (CENELEC)	Ex II 3G Ex nA op is IIB T4 Gc X
	Ex II 3D Ex tc IIIC T90°C Dc IP67 X

Options

Warning output autoControl warn	PNP transistor, counting principle
Signal voltage high/low	$\geq (U_B - 2V) \leq 2V$
Output current	max. 100mA

- 1) Typ. scan. range limit: max. achievable scanning range for light objects (white 90%)
- 2) Scanning range: recommended scanning range for objects with different diffuse reflection
- 3) Average life expectancy 100,000 h at an ambient temperature of 25°C
- 4) The push-pull switching outputs must not be connected in parallel
- 5) Suitable spark extinction must be provided with inductive or capacitive loads
- 6) Model "S"=standard housing, model "W"= with lateral flange
- 7) 2=polarity reversal protection, 3=short circuit protection for all outputs
- 8) Rating voltage 50VAC

Order guide

Connection diagram no.

Designation

Part no.



Cable with M12 connector, length: 200mm

Complementary push-pull switching output

Housing model S (standard) 1 HRT 46B/66, 200-S12 S-Ex n 50108587

PNP switching output light switching, warning output

Housing model S (standard) 3 IHRT 46B/4, 200-S12 S-Ex n 50108943

PNP switching output light switching, warning output + operating range adjustment

Housing model S (standard) 3 IHRT 46B/4.01, 200-S12 S-Ex n 50112802

HRT 46B/66, 200-S12 S-Ex n - 07

Tables

1	0	2,500
2	5	1,800
3	10	1,200

1	white 90%
2	gray 18%
3	black 6%

Scanning range [mm]

Diagrams

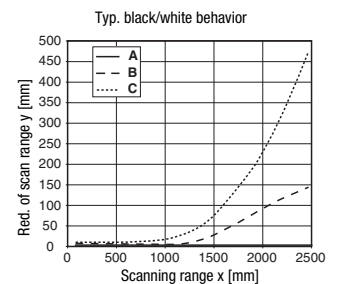
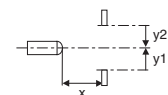
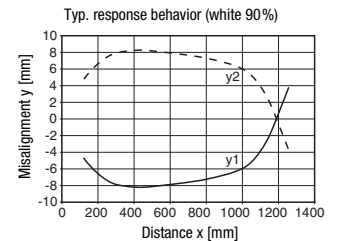

- A white 90%
- B gray 18%
- C black 6%

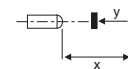

Remarks

Operate in accordance with intended use!

- ⚠ This product is not a safety sensor and is not intended as personnel protection.
- ⚠ The product may only be put into operation by competent persons.
- ⚠ Only use the product in accordance with the intended use.

- With the set scanning range, a tolerance of the upper scanning range limit is possible depending on the reflection properties of the material surface.

Ex devices

Notices for the safe use of sensors in potentially explosive areas

This document is valid for devices with the following classifications:

Device group	Device category	Equipment protection level	Zone
II	3G	Gc	Zone 2
II	3D	Dc	Zone 22



Attention!

- Check whether the equipment classification corresponds to the requirements of the application.
- The devices are not suited for the protection of persons and may not be used for emergency shutdown purposes.
- A safe operation is only possible if the equipment is used properly and for its intended purpose.
- Electrical equipment may endanger humans and (where applicable) animal health, and may threaten the safety of goods if used incorrectly or under unfavorable conditions in potentially explosive areas.
- The applicable national regulations (e.g. EN 60079-14) for the configuration and installation of explosion-proof systems must be observed without fail.

Installation and Commissioning

- The devices must only be installed and commissioned by trained electricians. They must be aware of the regulations and operation of explosion-proof equipment.
- To prevent unintentional separation under voltage, devices with connector (e.g. Series 46B) must be equipped with a safeguard or a mechanical interlocking guard (e.g. K-VM12-Ex, part no. 50109217). The warning sign "Do not disconnect under voltage" that is supplied with the device must be attached to the sensor or its mounting bracket so that it is clearly visible.
- Devices with terminal compartment lid (e.g. Series 96) must only be commissioned if the terminal compartment lid of the device is properly sealed.
- Connection cables and connectors must be protected from excessive or unintended pulling or pushing strain.
- Prevent dust deposits from forming on the devices.
- Metallic parts (e.g. housing, mounting devices) are to be integrated into the potential equalization to prevent electrostatic charge.

Maintenance

- No changes may be made to explosion-proof devices.
- Repairs may only be performed by a person trained for such work or by the manufacturer.
- Defective devices must be replaced immediately.
- Cyclical maintenance is generally not necessary.
- Depending on the environmental conditions, it may occasionally be necessary to clean the optical surfaces of the sensors. This cleaning must only be performed by persons trained for this task. We recommend using a soft, damp cloth. Cleaning agents that contain solvents must not be used.

Chemical resistance

- The sensors demonstrate good resistance against diluted (weak) acids and bases.
- Exposure to organic solvents is possible only under certain circumstances and only for short periods of time.
- Resistance to chemicals must be examined on a case by case basis.

Special conditions

- The devices must be installed in such a way that they are protected from direct exposure to UV rays (sunlight).
- Static charge on plastic surfaces must be avoided.

